

OCBP-4418(P) Manual valve

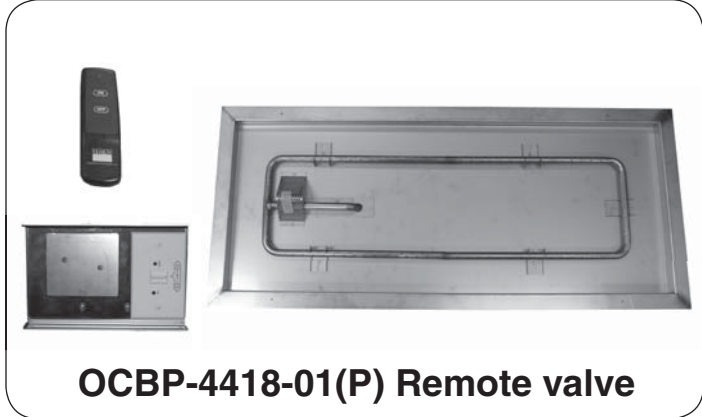

OCBP-4418-01(P) Remote valve

RECTANGULAR OUTDOOR CAMPFIRE CONTROL SYSTEM

WARNING: If the information in this manual is not followed exactly, a fire or explosion may result causing property damage, personal injury or loss of life.

- Do not store or use gasoline or other flammable vapors and liquids in the vicinity of this or any other appliance.

WHAT TO DO IF YOU SMELL GAS:

- Do not try to light any appliance.
- Do not touch any electrical switch; do not use any phone in your building.
- Immediately call your gas supplier from a neighbor's phone. Follow the gas supplier's instructions.
- If you cannot reach your gas supplier, call the fire department.

Installation and service must be performed by an NFI Certified or other qualified professional installer, service agency, or gas supplier.

WARNING: For Outdoor Use Only



Certified to
CSA International
4.96 US-2004
for outdoor gas
fireplaces

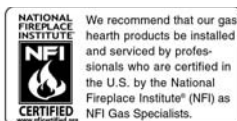

INSTALLER & CONSUMER: These instructions MUST be retained with this appliance for future reference.

Important: Read these instructions carefully before starting installation of the unit.

WARNING

Improper installation, adjustment, alteration, service, or maintenance can cause property damage, personal injury, or loss of life. Read the installation, operating and maintenance instructions thoroughly before installing or servicing this equipment.

This appliance is designed as an **attended appliance**. Adults **must** be present when the unit is operating. **DO NOT** leave this unit burning when unattended. If this product is left burning unattended, it may cause damage or serious injury.

IMPORTANT

For safe operation and proper performance of this product and to comply with certification, listings, and building code acceptances, use **ONLY** Peterson Real-Fyre® controls, parts, and accessories that have been specifically listed or certified for use with this burner system. Use of other controls, parts, or accessories is prohibited and will void all warranties, certifications, listings, and building code approvals, and may cause property damage, personal injury, and loss of life.

CODE AND SUPPLY REQUIREMENTS:

The installation must conform with local codes and ordinances, or, in the absence of local codes, with the latest *National Fuel Gas Code, ANSI Z223.1*.

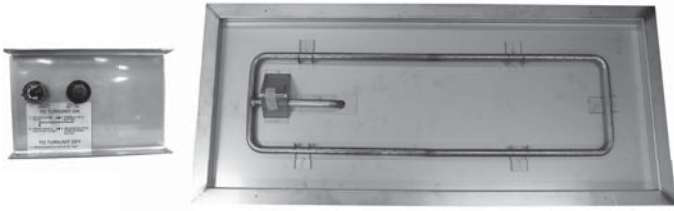

OCBP-4418(P) Manual valve

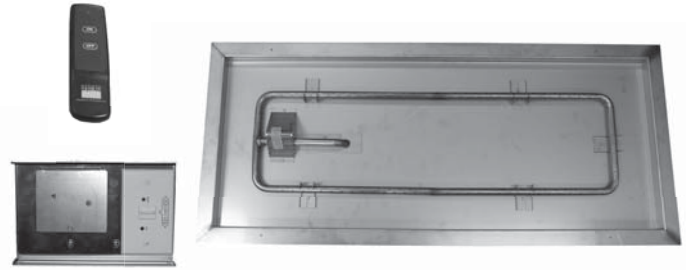

OCBP-4418-01(P) Remote valve

SYSTÈME DE CONTRÔLE EXTÉRIEUR RECTANGULAIRE DE CAMPFIRE

AVERTISSEMENT: Si l'information en ce manuel n'est pas suivie exactement, une incendie ou une explosion peut résulter entraînant des dégâts matériels, le dommage corporel ou des pertes humaines.

- Ne stockez pas ou n'employez l'essence ou d'autres vapeurs et liquides inflammables à proximité de ceci ou d'aucun autre appareil.

CE QUI À FAIRE SI VOUS SENTEZ LE GAZ:

- N'essayez pas de n'allumer aucun appareil.
- Ne touchez aucun commutateur électrique ; ne font pas nous aucun téléphone dans votre bâtiment.
- Appelez immédiatement votre fournisseur de gaz d'un neighbor'; téléphone de s. Suivez le gaz supplier'; instructions.
- Si vous ne pouvez pas atteindre votre fournisseur de gaz, appelez les corps de sapeurs-pompiers.

L'installation et le service doivent être assurés par un NFI certifié ou toute autre installateur, agence de service, ou fournisseur professionnelle qualifiée de gaz.

AVERTISSEMENT: Pour l'usage extérieur seulement

d'INSTALLATEUR; CONSOMMATEUR: Ces instructions DOIVENT être maintenues avec cet appareil pour la future référence.

Important: Lisez ces instructions soigneusement avant de commencer l'installation de l'unité.

AVERTISSEMENT

L'installation, l'ajustement, le changement, le service, ou l'entretien inexact peuvent causer des dégâts matériels, le dommage corporel, ou des pertes humaines. Lisez l'installation, l'opération et les instructions d'entretien complètement avant d'installer ou entretenir cet équipement.

Cet appareil est conçu comme appareil occupé. Les adultes doivent être présent quand l'unité fonctionne. Ne laissez pas ce burning d'unité si sans surveillance. Si ce produit est laissé sans surveillance brûlant, il peut causer des dommages ou des dommages sérieux.

IMPORTANT

Pour l'exploitation sûre et l'exécution appropriée de ce produit et pour se conformer à la certification, aux listes, et aux acceptations de codes du bâtiment, commandes, pièces, et accessoires de Peterson d'utilisation SEULEMENT Vrais-Fyre® qui ont été spécifiquement énumérés ou certifiés pour l'usage avec ce système de brûleur. L'utilisation d'autres commandes, pièces, ou accessoires est interdite et videra toutes les garanties, certifications, listes, et approbations de codes du bâtiment, et peut causer des dégâts matériels, le dommage corporel, et des pertes humaines.

CONDITIONS DE CODE ET D'APPROVISIONNEMENT: L'installation doit se conformer aux codes locaux et aux ordonnances, ou, en l'absence des codes locaux, au plus défunt code national de gaz de carburant, la norme ANSI Z223.1.



Certifié à CSA 4.96
US-2004 Internationaux pour les cheminées du gaz de plein air

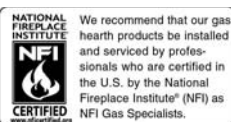

TABLE OF CONTENTS

PARTS LIST	4
PRE-INSTALLATION AND PREPARATION SAFETY GUIDELINES	5
INSTALLATION SAFETY GUIDELINES	6
OPERATING THE UNIT SAFELY AND CORRECTLY	6
IMPORTANT SAFETY INFORMATION	7
MINIMUM CLEARANCE TO COMBUSTIBLES	7
INSTALLATION	7
INSTALLATION SPECIFICATIONS	8
CONNECT TO THE GAS SUPPLY	9
LEAK TEST	9
CONVERTING TO A DIFFERENT GAS TYPE	10
INSTALLING/REPLACING BATTERIES	11
OPTIONAL GLASS OR RIVER ROCK ON GLASS	12
REMOTE LIGHTING INSTRUCTIONS	13
MANUAL LIGHTING INSTRUCTIONS	15
OPERATION	17
CLEANING & MAINTENANCE	17
PETERSON CAMPFYRE LIMITED WARRANTY	18

PARTS LIST

REMOTE VALVE

NO. DESCRIPTION

1. Burner pan assy
2. Control panel assembly
3. 24 "Flex connector (2)
4. Pilot assembly
5. Remote handset

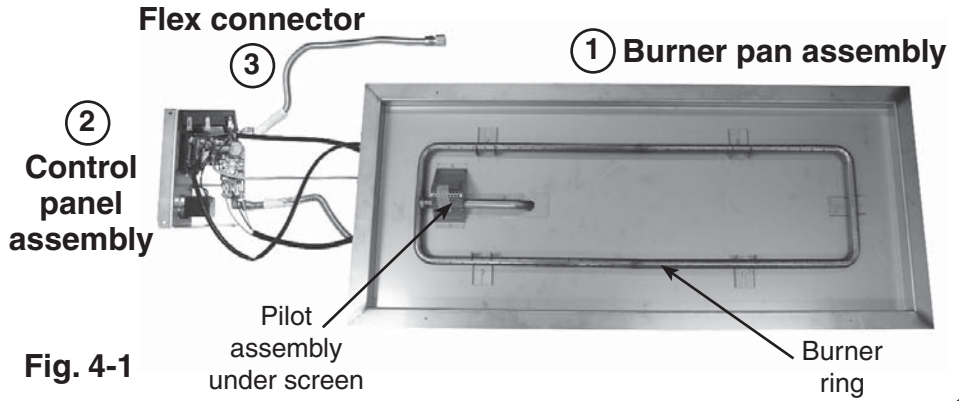

Fig. 4-1

2 Control panel front view

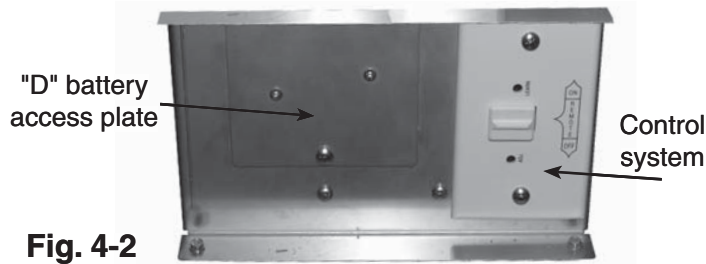

Fig. 4-2

4 Pilot assembly (under screen)

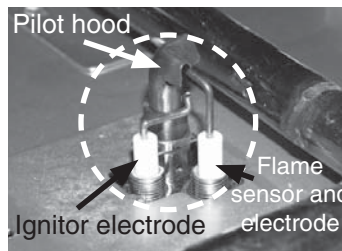

Fig. 4-3

5 Remote handset Control buttons



Fig. 4-4

Contact your local dealer for replacement parts

MANUAL VALVE

NO. DESCRIPTION

1. Burner pan assy
2. Control panel assembly
3. 24 "Flex connector (2)
4. Ignitor assy

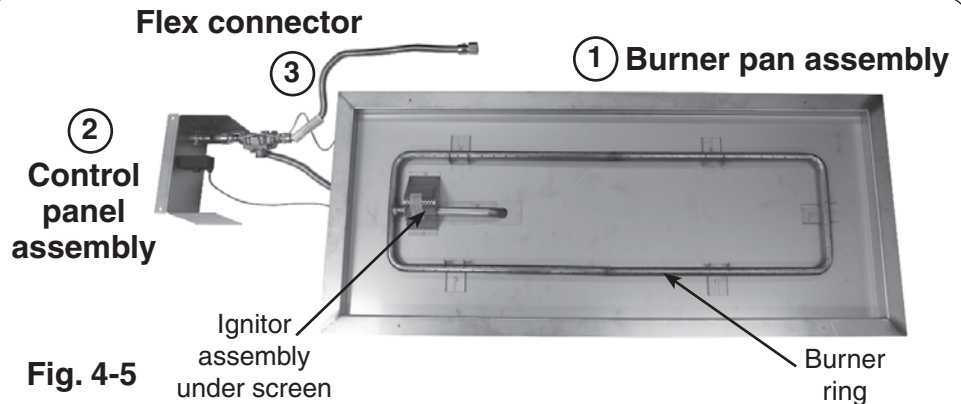

Fig. 4-5

2 Control panel front view



Fig. 4-6

4 Ignitor assembly (under screen)

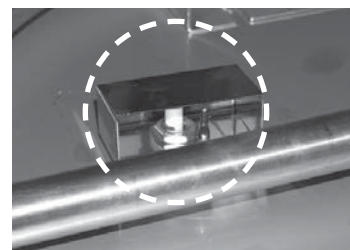

Fig. 4-7

PRE-INSTALLATION AND PREPARATION SAFETY GUIDELINES

- A.** Before installing this unit, check **MINIMUM CLEARANCE TO COMBUSTIBLES** (p. 7) to ensure that the surrounding area is **properly sized for the installation**.
- B.** The unit is for outdoor use only. **DO NOT** install or use this appliance inside a building, garage, or any other enclosed area, including recreational vehicles and/or boats. **This unit must be installed in such a manner that the vent opening at the base of the unit remains clear and free of all obstructions at all times and during all weather conditions.**
- C. CHECK GAS TYPE** (natural gas or propane): The gas supply you intend to use may not be the same as that stated on the outdoor campfire kit rating plate as purchased. If the gas supply is different, **convert the unit to the gas type you intend to use**. See instructions on p. 10. If you are unsure, contact the dealer for assistance. **ONLY MANUAL UNITS ARE CONVERTIBLE.**
- D. FOR NATURAL GAS:** The minimum inlet gas-supply pressure for purposes of input adjustment is **5"** water column (w.c.), and the maximum inlet gas-supply pressure is **10.5"** w.c. **FOR PROPANE:** The minimum inlet gas-supply pressure for purposes of input adjustment is **8"** w.c., and the maximum inlet gas-supply pressure is **13"** w.c. **DO NOT INSTALL THIS UNIT IF MINIMUM PRESSURE IS NOT AVAILABLE OR IF MAXIMUM PRESSURE IS EXCEEDED.**
- E.** Gas piping system must be sized to provide minimum inlet pressure at the maximum flow rate (BTU/hr). Undue pressure loss will occur if the pipe is too small, or the run is too long.
- F.** For installations at elevations above 2,000 ft., contact your local dealer or gas supplier before installing. Input ratings should be reduced approximately 4% for each 1,000 ft. above sea level. Refer to the National Fuel Gas Code.
- G.** The unit and its individual shutoff valve must be disconnected from the gas-supply piping system during any pressure testing of that system at test pressures in excess of 1/2 psi (3.5 kPa). This is accomplished by closing the gas-supply line valve. The unit must be isolated from the gas-supply piping system by closing its individual manual shutoff valve during any pressure testing of the gas-supply piping system at test pressures equal to or less than 1/2 psi (3.5 kPa).
- H. INSTALLER NOTE:** This unit should be installed so that it can be removed if service is required. Any protrusion into the unit enclosure may obstruct the frame and prevent the unit from being removed (see **GAS-SUPPLY PLUMBING REQUIREMENTS** below).
- I. GAS-SUPPLY PLUMBING REQUIREMENTS**
- Apply only joint compounds that are resistant to all gasses on all male pipe fittings. Make sure to tighten every joint securely. Do not use pipe joint compound to connect flare fittings. The gas-supply pipe should enter from the floor in the center of the enclosure. If it is not possible to stub the gas line in from the center of the enclosure, the connection may be made through the side of the enclosure.
- CAUTION:** Installation and maintenance must be done by an NFI Certified or other qualified professional installer. Installer, read these instructions before installing this product. Be sure you understand all safety precautions and warnings contained in this manual.

Note: An external on/off valve in the gas line is required for safety when the unit is not in use. It also provides for convenient maintenance and repair.

INSTALLATION SAFETY GUIDELINES

- A. Installation and repair should be done by a qualified service person. The appliance should be inspected before use and at least annually by a qualified service person. More frequent cleaning may be required as necessary. It is imperative that control compartment, burners and circulating air passageways of the appliance be kept clean.
- B. Carefully inspect for shipping damage. If any parts are damaged, call the dealer.
- C. Correct installation and proper placement of the unit and decorative media is crucial to the safe performance of the unit. See installation instructions (pages 10-12) for further information. **NEVER COVER THE BURNER SCREEN WITH DECORATIVE MEDIA OR ANY OTHER ITEM. THIS WILL IMPAIR ITS EFFICIENCY AND CAUSE THE UNIT TO MALFUNCTION.**
- D. Ensure that the unit is installed in such a manner that the vent opening at the base of the unit remains obstacle-free at all times and during all weather conditions (see Fig. 15-1).
- E. Due to high temperatures, the unit must be located out of traffic areas and away from combustibles.

OPERATING THE UNIT SAFELY AND CORRECTLY

- A. When shutting the unit down—be sure to TURN THE CONTROL VALVE FULLY OFF.
- B. Children MUST be carefully supervised when they are in the area of this appliance.
- C. DO NOT sit or place any part of the body, clothing, or other flammable materials on or near the unit surround. Children and adults should be alerted to the hazard of high surface temperatures and should stay away to avoid burns or clothing ignition.
- D. Every time you use the unit, make sure that:
 - 1. The area around the unit is clear and free from combustible materials, gasoline and other flammable vapors and liquids.
 - 2. **THE SCREEN IS NOT COVERED OR BLOCKED WITH DECORATIVE MEDIA OR ANY OTHER ITEM (see the GLASS PLACEMENT section and Fig. 12-2).**
 - 3. There is no blockage of the airflow through the vent openings (see Fig. 15-1) located on the bottom of the unit.
- E. **WARNING: HOT WHILE IN OPERATION AND FOLLOWING OPERATION.** Serious injury can occur! **DO NOT** throw trash, paper, or other flammable materials onto the unit. **DO NOT** leave in operation when unattended.
WARNING: DO NOT operate this unit in the rain.
- F. SOLID FUEL MUST NOT BE BURNED in the unit.
- G. **DO NOT** continue using if you smell unusual odors, or have headaches, nausea, or dizziness.
- H. **DO NOT** store any combustible materials, gasoline, and any other flammable vapors/liquids in the vicinity of the unit. Provide adequate clearance for servicing and operation.
- I. Matches, paper, garbage, or any other material must not be thrown onto the unit or into the flame.
- J. **DO NOT** use the unit if any part of it has been underwater. Immediately call a qualified professional service technician to inspect the set and to replace any part of the control system that has been underwater.

IMPORTANT SAFETY INFORMATION

BE CAREFUL

If not installed and used correctly per these instructions, this product can cause serious injury.

CAUTION: Installation and maintenance must be done by an NFI Certified or other qualified professional installer. Read these instructions before installing this unit. Be sure you understand all safety precautions and warnings contained in this manual.

A. FOR OUTDOOR USE ONLY.

B. When shutting the unit down—be sure to **TURN THE CONTROL VALVE FULLY OFF.**

C. WARNING: CARBON MONOXIDE POISONING MAY LEAD TO DEATH. DO NOT MODIFY THIS unit OR ITS CONTROLS, EXCEPT AS PROVIDED FOR IN THIS MANUAL. Any other change may be dangerous. Improper installation or use of the unit can cause serious injury or death from fire, burns, explosions, or carbon monoxide poisoning.

D. Check state and local codes to determine if the unit is permitted in your locality before installation.

E. The manual valve allows adjustable flame height and heat output. **THESE SETTINGS MUST ALWAYS BE HIGH ENOUGH FOR THE FLAME TO BE CLEARLY VISIBLE.**

MINIMUM CLEARANCE TO COMBUSTIBLES

Fig. 7-1

Note: Nothing should be above the unit.

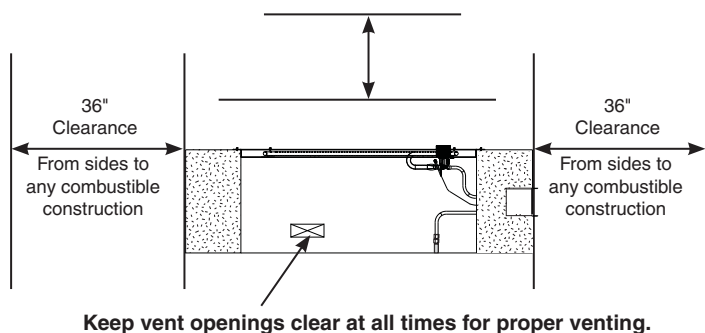

Clearances to Combustible Construction:

Side walls: 36" from each side of the enclosure.

Ceiling: **Nothing should be above the unit.**

Flooring: 0" - Can be installed on deck, slab, floor, etc.

The dimensions shown in Fig. 7-1 are **MINIMUM CLEARANCES** to maintain when you install this unit. **ALL SIDES** of the enclosure opening **MUST BE AT LEAST 36"** from any combustible side walls. The unit **MUST NOT BE** installed under any type of ceiling or overhang.

INSTALLATION

Important: Be sure you have read and understand all safety precautions and warnings contained in this manual.

BEFORE PROCEEDING, CAREFULLY READ ALL OF THE IMPORTANT SAFETY INFORMATION CONTAINED IN THIS OWNER'S MANUAL, INCLUDING:

- IMPORTANT SAFETY INFORMATION.
- INSTALLATION SAFETY GUIDELINES.
- MINIMUM CLEARANCE TO COMBUSTIBLES.

BE SURE THE GAS SUPPLY FOR THE UNIT IS TURNED OFF.

Note: When installing the unit to natural gas or household propane, you must have a gas-supply line that has been installed by a qualified professional technician in accordance with all local codes. **Refer to the PARTS LIST when installing the unit.**

INSTALLATION (Cont.)

INSTALLATION SPECIFICATIONS

When installing in your enclosure, allow a minimum of 8" (vertical) from the bottom of the control system to the burner pan (Fig. 8-1). This will allow adequate access for maintenance and troubleshooting.

Note: Two vent openings for adequate combustion air must be provided (Fig. 8-1).

Recommended Installation Specifications (nominal)

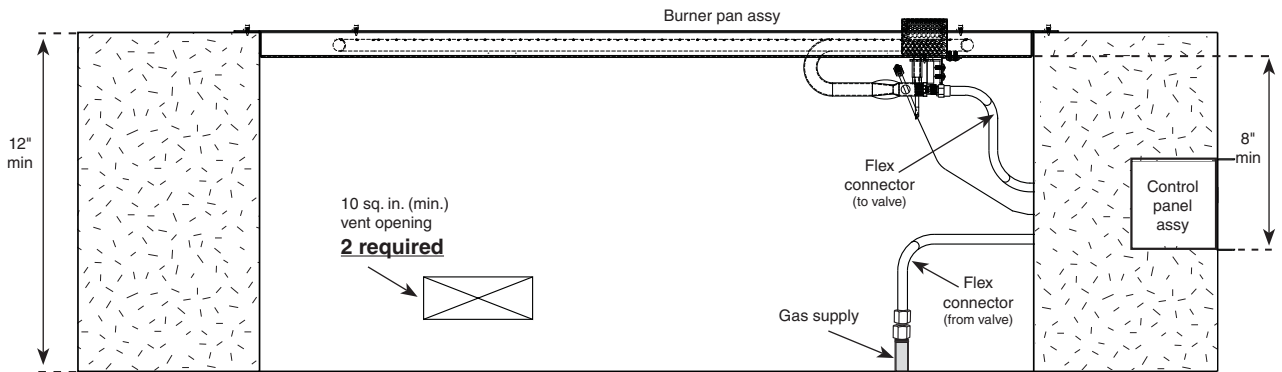

Fig. 8-1

Top view

The maximum distance is the flex connector length, while meeting all requirements in Fig. 8-1.

Note: The recommended cutout/opening in the enclosure for this burner pan is 17 3/4" x 43 3/4".

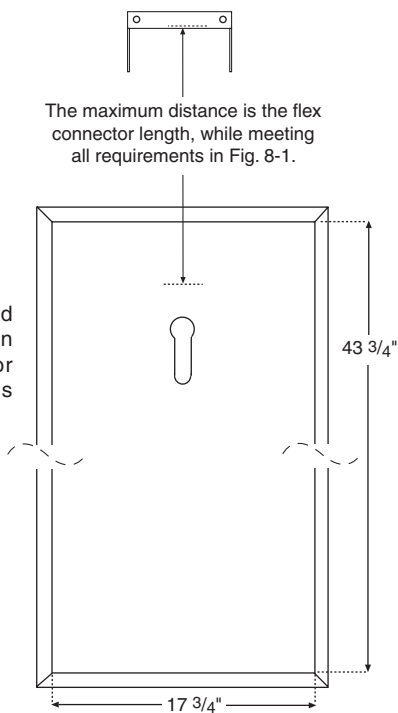

Fig. 8-2

Control system dimensions

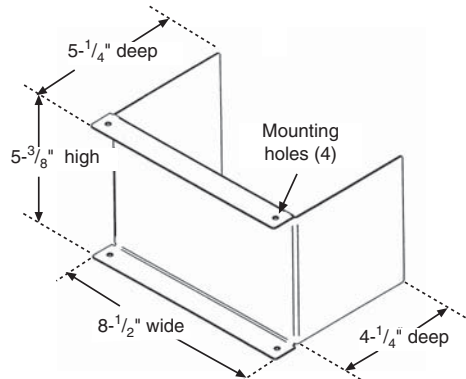

Fig. 8-3

CONNECT TO THE GAS SUPPLY

1. Bring the gas-supply pipe up from beneath the unit near its center.

Note: Locate the gas supply line out of pathways where people may trip over it or in areas where the line may be subject to accidental damage.

2. Install the supplied flare adaptor to the gas supply (NPT) using a gas pipe sealing compound or Teflon tape (see Fig. 9-1).
3. Connect the flex connector coming from the valve assembly to the gas supply adaptor (see Fig. 9-1).

LEAK TEST

Turn on the gas supply, ignite the burner, and test at all connections for leaks using a soapy water solution. If bubbles appear, a leak is present. Turn off the gas and tighten at all connections. Repeat until no leaks are present. If a leak persists, turn off the gas supply and contact the local gas company or dealer. **NEVER USE A FLAME TO CHECK FOR LEAKS.**

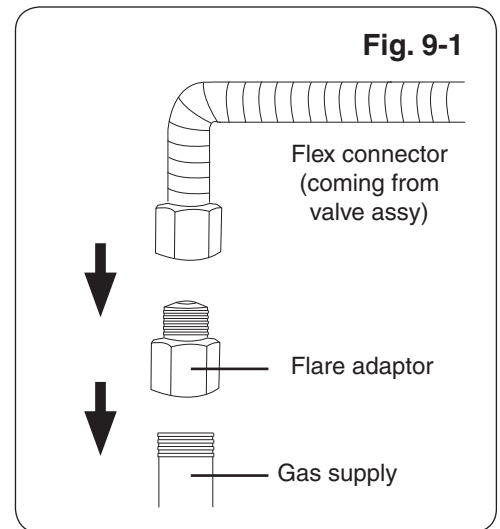

CONVERTING TO A DIFFERENT GAS TYPE

To convert **manual units** from propane to natural gas or from natural to propane gas, carefully follow the steps below:

1. **SHUT OFF THE GAS SUPPLY TO THE UNIT AND ANY NEARBY ELECTRICAL SOURCES OR APPLIANCES.**
2. If present, remove all decorative media from the unit.
3. Remove the screws attaching the burner pan to your enclosure.
4. Detach the thermocouple (taking care not to kink it) from the safety valve (see Fig. 10-2 for location).
5. Carefully detach the flex connector attached to the orifice holder (see Fig. 10-4) and unscrew the orifice holder from the burner pipe (see Fig. 10-5).
6. Remove the orifice from the holder (see Fig. 10-5) and replace with the proper-sized one for your gas requirement. Propane gas requires a #36 (drill size) orifice. Natural gas requires a #1 orifice.

Note: If you are converting **to and using natural gas** you **MUST** install the air shutter over burner pipe to cover the air holes (see Fig. 10-5). For **propane (L.P.)** gas, remove the air shutter.

Replace the orifice holder and reattach the connector from the valve (see Fig. 10-4). The regulator must now be converted to the new gas type.

7. The regulator is situated after the valve (see Fig. 10-2), behind the control panel. To convert the regulator to the required gas type:
 - a) Unscrew and remove the cap (see Fig. 10-1) from the regulator, extracting the converter.

Note: As installed, the regulator cap may be located underneath the regulator. If necessary, carefully rotate the regulator to access the cap.

- b) Remove the converter (the red plastic stalk, Fig. 10-1) by carefully pulling it away from the center of the cap (it will snap out of its seating).
 - c) Turn the converter around and replace carefully into the center of the cap (it will snap into place). **Check that you can read the type of gas the unit is set for.**

Note: **EACH END OF THE PLASTIC CONVERTER IS EMBOSSED WITH EITHER THE LETTERS "NAT" OR "L.P." FOR THE RESPECTIVE GAS TYPE ("NAT." for natural - "L.P." for propane). WHEN THE CONVERTER IS IN THE CAP AND THE CAP IS HELD UPPERMOST, THE LETTERS SEEN (AT THE BOTTOM OF THE STALK) INDICATE THE GAS THAT THE REGULATOR IS SET UP FOR.** (Fig. 10-1 shows the converter set for propane gas.)

- d) Replace the cap and converter into the regulator and screw down until snug.

8. Once the above steps are complete, reattach the thermocouple and ignitor wires.
9. Restore your gas supply and check for leaks per the INSTALLATION section. When no leaks are detected, fasten the burner pan back into place on the enclosure and replace the decorative media.

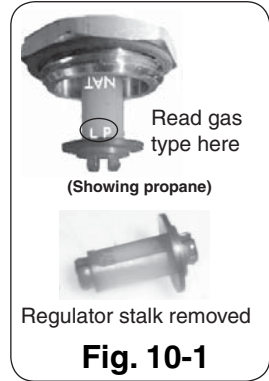
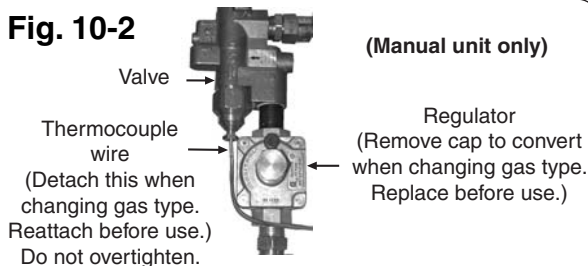
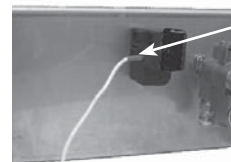

Fig. 10-1

Fig. 10-2



Ignitor module (rear view)



Ignitor wire
(Detach when changing orifice for different gas type. Replace before use.)

(Manual unit only)

Fig. 10-3

Connector from valve attached to orifice holder on burner pipe

Fig. 10-4

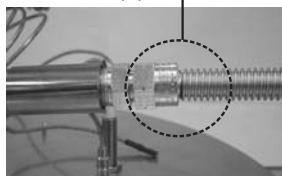

Detach connector from orifice holder when changing orifice to a different gas type.

Fig. 10-5

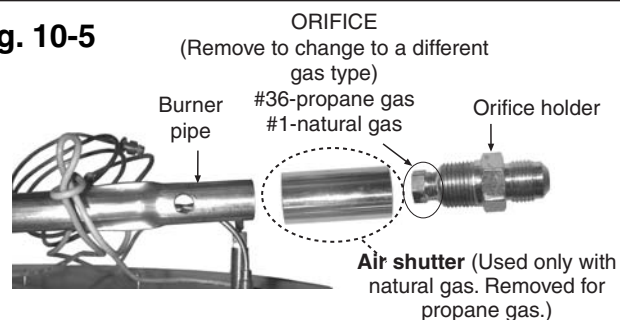

INSTALLING/REPLACING BATTERIES

CAUTION: ENSURE THE UNIT IS CONNECTED TO THE GAS LINE AND HAS BEEN TESTED FOR LEAKS BEFORE YOU INSERT BATTERIES.

INSTALLING/REPLACING THE BATTERIES FOR REMOTE UNITS

To access the "D" battery pack, unscrew the access plate on the left side of the control panel. Only unscrew the large retaining screw. Grip the top half of the access plate and pull it out to expose the "D" battery pack (Fig. 11-1). Replace the old batteries with two (2) new "D" batteries. Return the access plate into the control panel. Screw in the large retaining screw.

To access the "AA" battery pack, unscrew and remove the two (2) retaining screws on the control system. Pull out the control system and then slide open the battery pack lid as shown in Fig. 11-2. Replace the old batteries with four (4) new "AA" batteries. Resecure the battery pack lid and return the control system into the control panel. Screw in the two (2) retaining screws.

INSTALLING/REPLACING THE SPARK GENERATOR BATTERY FOR MANUAL UNITS

To access the "D" battery pack, unscrew the complete generator cap (Fig. 11-3). Withdraw the existing battery and spring (Fig. 11-4) and detach the "AA" battery. Insert the new battery (negative end first) into the spring. Insert the battery and spring into the generator and replace the cap, screwing down until snug. Do not overtighten.

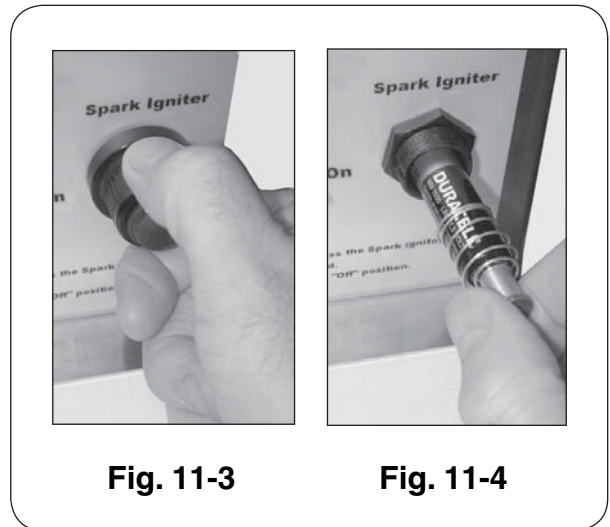
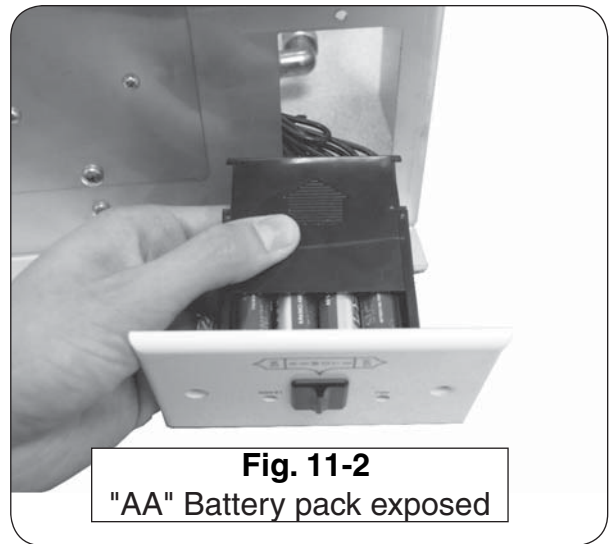

OPTIONAL GLASS OR RIVER ROCK ON GLASS

These setup instructions are your reference. None of these options come with the outdoor campfire kit unless ordered separately.

IMPORTANT: This gas burner must be surrounded by a medium comparable to the lava chunks shown in the following options to work safely and as designed.

#	Description	Part Number	Qty
1.	Glass (10-lb. bag)	OCGL-x	3
2.	Lava chunks (10-lb. bag)	OCC-10	2
3.	Box of river rock (optional)	STN-10	1 or 2 as desired

Replace "x" in model number with the glass code in parentheses below:

- Black (B)
- Clear (C)
- Bronze (Z)
- Sapphire blue (S)
- Emerald green (E)

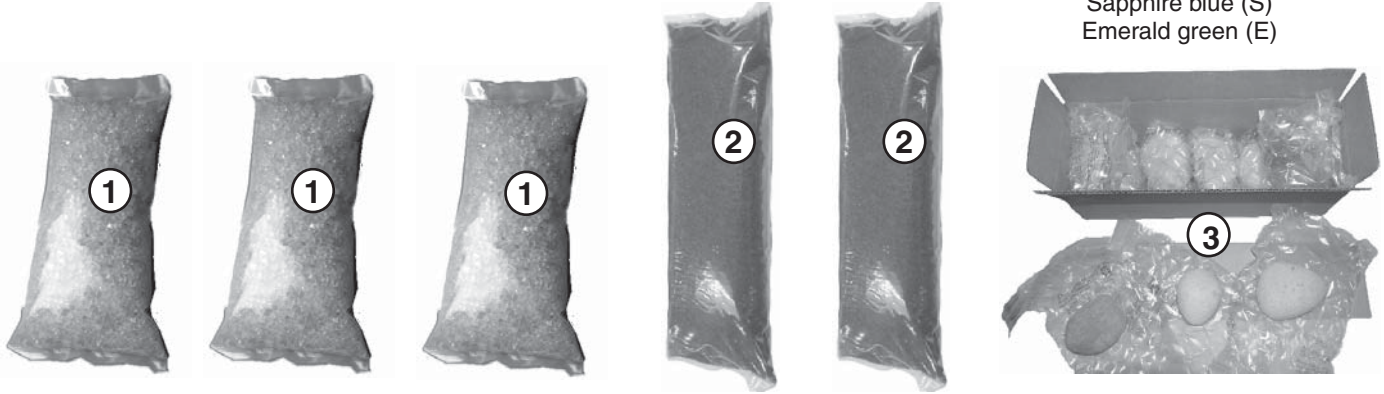

WARNING

This screen must be clear and free of obstructions at all times to ensure proper operation (Fig. 12-1).

Screen with lava chunks on burner pan

**DO NOT PLACE
LAVA CHUNKS
ON THE SCREEN**

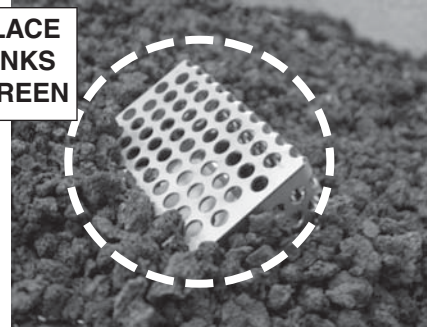

Fig. 12-1

LAVA CHUNK PLACEMENT

1. Pour the two (2) bags of lava chunks (PARTS LIST, item #2) into the burner pan, evenly covering the burner pan assembly with the exception of the screen.

GLASS PLACEMENT

1. Pour the glass out of the bag(s), evenly covering the lava chunks (see above) but not the screen (Fig. 12-2).

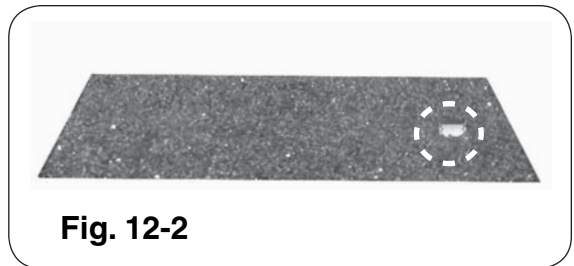

Fig. 12-2

STONE PLACEMENT

1. Place river stones in a decorative pattern on top of glass but not covering the screen.

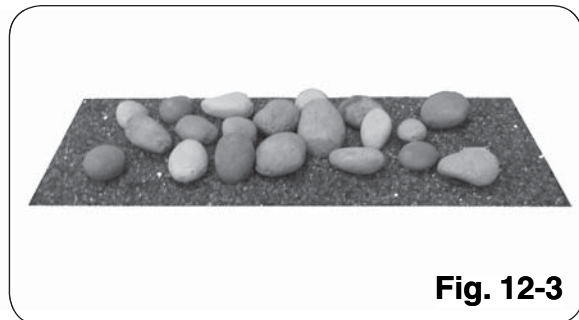

Fig. 12-3

CAUTION: CAMPFYRE OR DECORATIVE MEDIA WILL REMAIN HOT FOR SOME TIME AFTER USE. IF YOU NEED TO REPOSITION ANY DECORATIVE MEDIA, USE HEAT-RESISTANT GLOVES OR ALLOW TO COOL BEFORE HANDLING.

OPERATING THE UNIT - LIGHTING AND EXTINGUISHING

FOR YOUR SAFETY, READ BEFORE LIGHTING

WARNING: IF YOU DO NOT FOLLOW THESE INSTRUCTIONS EXACTLY, A FIRE OR EXPLOSION MAY RESULT, CAUSING PROPERTY DAMAGE, PERSONAL INJURY, OR LOSS OF LIFE.

- A. BEFORE LIGHTING**, smell all around the unit area for gas. Be sure to smell next to the floor, because some gas is heavier than air and will settle on the floor.
- B. WHAT TO DO IF YOU SMELL GAS**
 1. **Shut off the gas to the appliance.**
 2. **Extinguish any open flame.**
 3. **If odor continues, immediately call your gas supplier or the fire department.**
- C.** Use only your hand to push in or turn the gas control knob. Never use tools. If the knob will not push in or turn by hand, **DO NOT** try to repair it. Call a qualified professional service technician. Force or attempted repair may result in fire or explosion.
- D. DO NOT** use the unit if any part has been underwater. Immediately call a qualified service technician to inspect the unit and to replace any part of the control system and any gas control that has been underwater.

REMOTE LIGHTING INSTRUCTIONS

Note: For any lighting method, no gas will flow to the main burner unless the pilot is lit and stable.

1. **STOP!** Read the safety information above.
2. Turn the gas valve to the **ON** position.
3. **Lighting the unit using remote handset**
 - a. Slide the ON/REMOTE/OFF switch (O/R/O) to **REMOTE** setting (see Fig. 13-1).
 - b. Point the top of the remote handset toward the control panel and press the **ON** button on the handset. The ignitor will spark and a rapid clicking noise will be heard. The pilot will light. When the pilot flame becomes stable (about 10 seconds), gas will flow to the main burner, and the main burner will ignite.
4. **Lighting the unit without using the remote**
 - a. Slide the O/R/O switch to the **ON** setting (top); the ignitor will spark, and a rapid clicking noise will be heard. The pilot will light. When the pilot flame becomes stable (about 10 seconds), gas will flow to the main burner, and the main burner will ignite.

SHUTTING OFF THE UNIT

5. **Shutting off the unit using remote handset**
 - a. Slide the ON/REMOTE/OFF switch (O/R/O) to **REMOTE** position (center).
 - b. Point the top of the remote handset toward the control panel and press the **OFF** button (handset). Main burner and pilot will extinguish.
6. **Shutting off the unit without using remote**
 - a. Slide the O/R/O switch to the **OFF** setting. Main burner and pilot will extinguish.

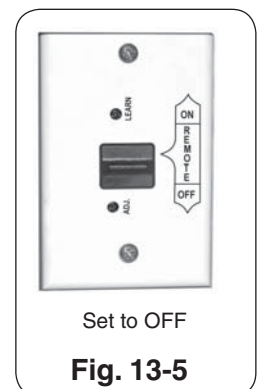
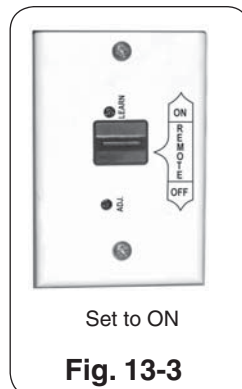
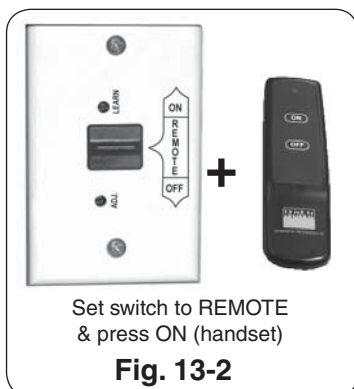
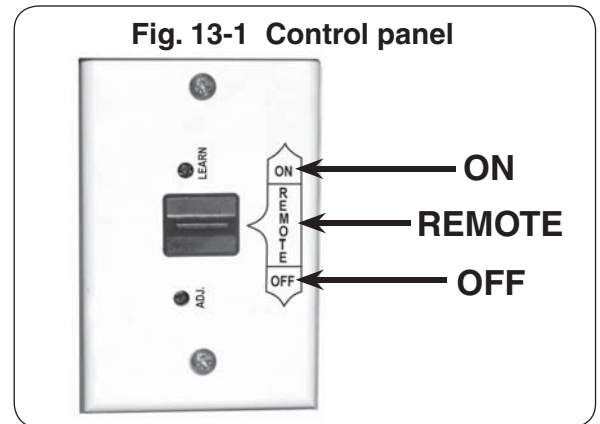

FONCTIONNEMENT DE L'ÎLE UNITÉ - ÉCLAIRAGE ET S'ÉTEINDRE

Pour votre sécurité lisez avant d'allumer

Avertissement. Quiconque ne respecte pas à la lettre les instructions dans la présente notice risque de déclencher un incendie ou une explosion entraînant des dommages, des blessures ou la mort.

AVANT DE S'ALLUMER, sentez tous autour de l'île unité secteur pour le gaz. Soyez sûr de sentir à côté de la terre, parce qu'un certain gaz est plus lourd que l'air et arrangerà sur le plancher. SI VOUS SENTEZ LE GAZ, SUIVEZ LES INSTRUCTIONS SUR La Page 1

N'emploient pas l'île unité si n'importe quelle partie a été sous-marine. Appelez immédiatement un technicien qualifié de service professionnel pour inspecter l'île unité et pour remplacer n'importe quelle partie du système de commande et de n'importe quel gaz commandez qui a été sous-marin.

N'utilisez pas cet appareil s'il a été plongé dans l'eau, même partiellement. Faites inspecter l'appareil par un technicien qualifié et remplacez toute partie du système de contrôle et toute commande qui ont été plongés dans l'eau.

INSTRUCTIONS À DISTANCE D'ÉCLAIRAGE

Note: Pour tout combinatin de l'éclairage utilisé, le gaz ne coulera pas au brûleur principal à moins que le pilote soit allumé et est logé dans une écurie.

- 1. ARRÊTEZ!** Lisez l'information de la sécurité fournie l'unité.
- 2. Tournez la valve du gaz au "SUR" place**
- 3. Allumer le unité qui utilise le combiné éloigné**
 - Poussée le. Éloigné/Sur/Fermé. changement (R/O/O) au. Éloigné. mettre (centre)(illus. 14-1).
 - Point le sommet du combiné éloigné vers le tableau de bord et presse le "SUR" bouton sur le combiné. Les ignitor jetteront des étincelles, un bruit du cliquetis rapide sera entendu. Le pilote allumera. Quand la flamme pilote devient stable, (approximativement 10 secondes) le gaz coulera au brûleur principal et le brûleur principal allumera
- 4. Allumer sans utiliser éloigné.**
 - Poussée le. R/O/O. changement au. SUR. mettre (sommet). Les ignitor jetteront des étincelles, un bruit du cliquetis rapide sera entendu. Le pilote allumera. Quand la flamme pilote devient stable, (approximativement 10 secondes) le gaz coulera au brûleur principal et allumer.

Couper le unité

- 5. Couper le unité qui utilise le combiné éloigné**
 - Quand utiliser le Combiné Éloigné; Assurez le changement est dans la place "Éloignée" (centre) Presse le "Fermé" bouton sur le combiné. Le brûleur principal et pilote seront éteints.
- 6. Couper le unité sans utiliser le combiné éloigné**
 - Quand n'utiliser pas Combiné Éloigné; Poussez les ON/OFF éteignent à. Le brûleur principal et le pilote sera éteint

illus. 14-1 panneau de commande

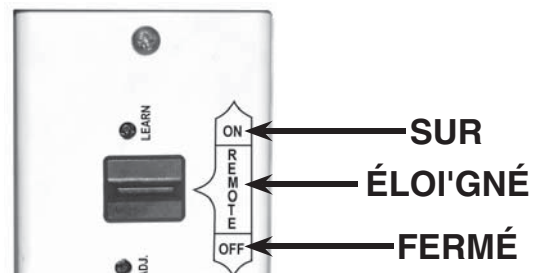

OU

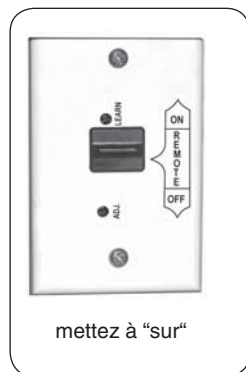

+



OU

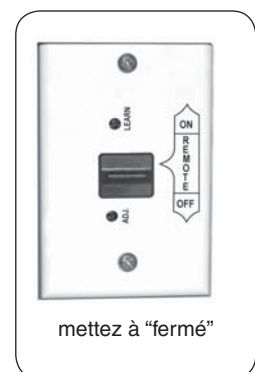

OPERATING THE UNIT - LIGHTING AND EXTINGUISHING

FOR YOUR SAFETY, READ BEFORE LIGHTING

WARNING: IF YOU DO NOT FOLLOW THESE INSTRUCTIONS EXACTLY, A FIRE OR EXPLOSION MAY RESULT, CAUSING PROPERTY DAMAGE, PERSONAL INJURY, OR LOSS OF LIFE.

- A. BEFORE LIGHTING**, smell all around the unit area for gas. Be sure to smell next to the floor, because some gas is heavier than air and will settle on the floor.
- B. WHAT TO DO IF YOU SMELL GAS**
1. **Shut off the gas to the appliance.**
 2. **Extinguish any open flame.**
 3. **If odor continues, immediately call** your gas supplier or the fire department.
- C.** Use only your hand to push in or turn the gas control knob. Never use tools. If the knob will not push in or turn by hand, **DO NOT** try to repair it. Call a qualified professional service technician. Force or attempted repair may result in fire or explosion.
- D. DO NOT** use the unit if any part has been underwater. Immediately call a qualified service technician to inspect the unit and to replace any part of the control system and any gas control that has been underwater.

MANUAL LIGHTING INSTRUCTIONS

1. **STOP!** Read the safety information above.
2. Press and hold the electric ignitor button. The ignitor will begin to spark with a rapid clicking sound.
3. While holding the ignitor button in, push in the ON/OFF control knob to open the gas valve.
4. Continue to hold the knob in for 10-15 seconds this will allow the safety valve to engage, and the main burner will ignite and remain lit. After releasing the knob turn the ON/OFF control knob to adjust flame height. If unit fails to light at step 4 after five (5) seconds, **STOP**, turn control knob to **OFF**, wait 5 minutes, and repeat steps 2 & 3.

Fig. 15-1

Follow the instructions on the control panel face to light the unit.

Note: Here the ON/OFF valve is in the **OFF** position.



Note: If the burner will not stay lit after several tries, turn the gas control knob to **OFF** and call your service technician or the gas supplier.

To turn the unit off, turn the ON/OFF valve fully to **OFF**.

FONCTIONNEMENT DE L'ÎLE UNITÉ - ÉCLAIRAGE ET S'ÉTEINDRE

POUR VOTRE SÛRETÉ, LISEZ AVANT DE S'ALLUMER

AVERTISSEMENT

SIVOUS NE SUIVEZ PAS CES INSTRUCTIONS EXACTEMENT, UNE INCENDIE OU UNE EXPLOSION PEUT RÉSULTER, ENTRAÎNANT DES DÉGATS MATÉRIELS, DES BLESSURES, OU LA PERTE DE LA VIE.

- A. AVANT DE S'ALLUMER**, sentez tous autour du secteur extérieur de feu de camp pour le gaz. Soyez sûr de sentir à côté du plancher, parce qu'un certain gaz est plus lourd que l'air et arrangera sur le plancher.
- B. CE QUI À FAIRE SI VOUS SENTEZ LE GAZ**
- 1. Coupez le gaz à l'appareil.**
 - 2. Éteignez-vous n'importe quelle flamme nue.**
 - 3. Si l'odeur continue, appelez immédiatement votre fournisseur de gaz ou le département de feu.**
- C.** Utilisez seulement votre main pour enfoncer ou pour tourner le bouton de commande de gaz. N'utilisez jamais les outils. Si le bouton n'enfoncera pas ou ne tournera pas à la main, n'essayez pas de le réparer. Appelez un technicien qualifié de service professionnel. La force ou la réparation essayée peut avoir comme conséquence l'incendie ou l'explosion.
- D.** N'employez pas le feu de camp extérieur si n'importe quelle partie a été sous-marine. Appelez immédiatement un technicien qualifié de service pour inspecter le feu de camp extérieur et pour remplacer n'importe quelle partie du système de commande et de n'importe quelle commande de gaz qui a été sous-marine.

INSTRUCTIONS MANUELLES D'ÉCLAIRAGE

- 1. ARRÊT!** Lisez l'information de sûreté ci-dessus.
- Appuyez sur et tenez le bouton électrique d'ignitor. L'ignitor commencera à étinceler avec un bruit cliquant rapide.
- Tout en tenant le bouton d'ignitor dedans, enfoncez le bouton de commande "marche/arrêt" pour ouvrir le clapet à gaz.
- Continuez à tenir le bouton dedans pendant 10-15 secondes où ceci permettra à la soupape de sûreté de s'engager, et le brûleur principal mettra à feu et rester s'est allumé. Après avoir libéré le bouton, tournez le bouton de commande "marche/arrêt" pour ajuster la taille de flamme. Si l'unité ne s'allume pas à l'étape 4 après cinq (5) seconde, S'ARRÊTENT, tournent le bouton de commande à AU LOIN, attendent 5 minutes, et répètent les étapes 2 et 3.

Note: Si le brûleur ne restera pas s'allumait après que plusieurs essais, tournent le bouton de commande de gaz à AU LOIN et appellent votre technicien de service ou le fournisseur de gaz.

Pour arrêter l'unité, tournez la valve "marche/arrêt" entièrement à AU LOIN.

Fig. 16-1

Suivez les instructions sur le visage de panneau de commande d'allumer le feu de camp.

Note: Ici la valve "marche/arrêt" est dans la position de repos.

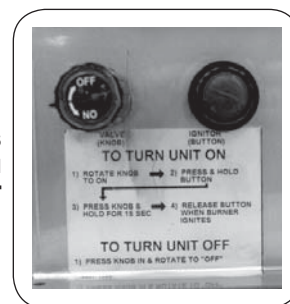

OPERATION

Each installation site for any unit presents its own unique combustion environment. Specific factors such as weather, wind currents, yard debris, altitude, drafts, the size of the surrounding area, etc., all have an influence on the proper operation of the unit. A normally operating unit will demonstrate the following characteristics:

- a) A lively, realistic yellow flame,
- b) Odor-free.
 - If the flame is not clean (identifiable by excessive sooting on the decorative media), refer to the CLEANING AND MAINTENANCE section below.

CLEANING & MAINTENANCE

- A. Always shut off the gas to the unit while performing service work.
- B. Allow the unit to cool before servicing.
- C. The unit should be inspected regularly. Excessive debris can build up on this unit from leaves, dirt, or other debris. It is critical that all control components, burners, burner screen, and vent openings be kept clean and free of all obstructions.

Keep the opening at the base of the enclosure clean and free of obstructions at all times.

Keep the screen on the burner pan clean and free of decorative media and other items that may cause obstruction.

- D. The burner assembly must be replaced prior to the unit being put into operation if it is evident that the burner is damaged. Contact your local dealer for replacement parts.
- E. Periodically perform visual checks of the pilot and burner flames. The pilot should be a steady flame, touching the electrode/thermocouple. The burner flames should be blue at the base with a combination of blue/yellow at the body and tips. Contact a qualified service person for maintenance.

CAUTION

HOT DURING OPERATION AND AFTER USE. Children must be supervised when in the vicinity of this appliance. Serious injury may occur! Children must be alerted to the hazard of high surface temperatures and should stay away to avoid burns or clothing ignition.

THREE (3) YEAR LIMITED WARRANTY

All Peterson Outdoor Campfyre logs, enclosures, and burner component parts, (except valves and controls) are covered by a three (3) year limited warranty.

All Peterson valves and controls are covered by a separate one (1) year limited warranty (excluding batteries).

PLEASE KEEP A COPY OF YOUR SALES SLIP FOR PROOF OF PURCHASE

This warranty applies to the original purchaser and to single family residential use only. It commences from date of purchase, and is valid only with proof of purchase.

This warranty does not cover parts becoming defective through misuse, accidental damage, electrical damage, improper handling, storage, and/or installation. Product must be installed (and gas must be connected) as specified in the instructions or operator's manual, by a **qualified professional installer**. Accessories, parts, valves, remotes, etc., when used must be Peterson Co. product.

This warranty **does not** apply to rust, corrosion, oxidation, or discoloration, unless the affected component becomes inoperable. It **does not** cover labor or labor-related charges.

This warranty specifically excludes liability for **indirect, incidental**, or consequential damages. Some states do not allow the exclusion or limitation of incidental or consequential damages, so the above exclusion may not apply to you. This warranty gives you specified legal rights, and you may have other rights that may vary from state to state.

For additional information regarding this warranty, or to place a warranty claim, contact the R.H. Peterson dealer where the product was purchased.

**TO REGISTER YOUR PRODUCT ONLINE GO TO: WWW.RHPETERSON.COM,
AND CLICK ON PRODUCT REGISTRATION. THANK YOU FOR YOUR PURCHASE.**

ROBERT H. PETERSON CO.

Quality Check

Date: _____

Orifice # (Main): _____

Orifice # (Other): _____

Leak Test: _____

Burn Test: _____

Gas Type: NAT. / PROPANE

Model #: _____

Serial #: _____

Air Shutter: _____

Inspector: _____